

ROTATION INVARIANCE OF CRITICAL PLANAR PERCOLATION
[after Hugo Duminil-Copin, Karol Kajetan Kozłowski, Dmitry Krachun,
Ioan Manolescu and Mendes Oulamara]

by **Vincent Tassion**

INTRODUCTION

Consider critical independent percolation on the square lattice \mathbb{Z}^2 , viewed as a graph: For each edge, flip a coin, the edge is kept with probability $p = 1/2$, it is deleted otherwise. We thus obtain a random subgraph of \mathbb{Z}^2 . The distribution of this random graph is invariant under rotation of angle $\pi/2$, as it inherits the symmetries of the lattice. But if we consider the large connected components, new symmetries emerge: Duminil-Copin, Kozłowski, Krachun, Manolescu, and Oulamara (2020) have shown that the distribution of these connected components is asymptotically invariant under all rotations. This result represents major progress towards understanding critical phenomena in planar statistical mechanics. The main conjecture in the field is that the distribution of large connected components is in fact invariant by conformal transformations, and it satisfies a principle of universality: this distribution does not depend on the underlying lattice. In this article, we give some general background on Bernoulli percolation, we state the new rotation invariance result and discuss some key aspects of it: what role does the parameter $1/2$ play? What heuristic reasons justify the emergence of these symmetries? What are the main ideas behind rotational invariance? We mainly focus on one important ingredient of the proof: the star-triangle transformation. Originated from the study of electrical networks, it allows the authors to relate percolation on the square lattice to other auxiliary graphs, and “import” extra symmetries satisfied by these graphs (namely symmetry under reflections).

Acknowledgment. — I warmly thank Ioan Manolescu, who explained to me the main ideas behind the proof of rotation invariance of critical percolation, and was a precious help in the preparation of this article. As always, I could count on Sébastien Martineau who made a detailed list of valuable comments and suggestions on a previous version of this article, leading to substantial improvements. I am also grateful to Christoforos Panagiotis and the two anonymous readers for useful comments. This work has received funding from the European Research Council (ERC) under the European Union’s Horizon 2020 research and innovation program (grant agreement No 851565).

1. PHASE TRANSITION OF BERNOULLI PERCOLATION

Bernoulli percolation was introduced in 1957 by Broadbent and Hammersley (1957) in order to understand the propagation of a fluid in a porous medium, modeled as follows. Consider the square lattice \mathbb{Z}^2 , which we see as a planar graph embedded in the complex plane: its vertex set is $V = \{u + iv : u, v \in \mathbb{Z}\}$, and the edge set E is given by all linear segments $[u, v]$ with $|u - v| = 1$. Fix a parameter $p \in [0, 1]$, which represents the porosity of the material we want to model.

For each edge $e \in E$ toss a biased coin, and define

$$\omega_e = \begin{cases} 0 & \text{with probability } 1 - p, \\ 1 & \text{with probability } p, \end{cases}$$

independently of the other edges. We say that the edge e is open if $\omega_e = 1$ (solid edges in the figure below) and closed if $\omega_e = 0$ (dotted edges).

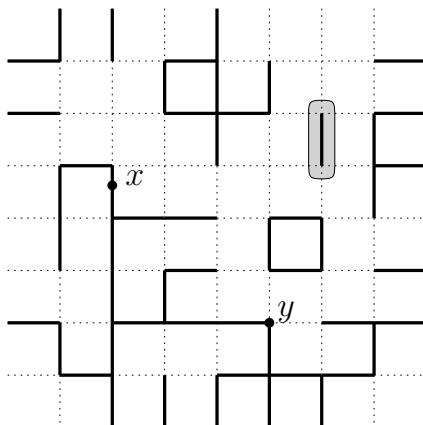

The terminology open/closed comes from the interpretation of ω as a porous material: the fluid can only travel through open edges, and percolation aims at describing the different paths that the fluid can follow. To this end, it is convenient to identify ω with the union of all the open edges. This way, we see ω as a closed subset of \mathbb{C} and define its corresponding topological properties. We call open path a continuous path with support in ω . For example, in the picture above, there exists an open path from x to y . We emphasize that we do not impose that the path starts and ends at vertices of \mathbb{Z}^2 . We call cluster a connected component of ω . For example, above, we surrounded a cluster made of a single edge. Despite this elementary mathematical description, Bernoulli percolation offers a natural probabilistic framework to develop and understand the theory of phase transitions, a key notion in statistical mechanics.

A natural question for Bernoulli percolation is whether there exists an infinite cluster in ω . The answer depends on the underlying parameter: if $p = 0$ we have $\omega = \emptyset$ and there is no infinite cluster. For $p = 1$ all the edges are open, and there is a unique infinite cluster. When p varies continuously from 0 to 1, we observe a drastic change of

behaviour at a certain critical value p_c . More precisely, elementary monotonicity and ergodic arguments show that there exists a critical parameter p_c such that

$$\begin{aligned} p < p_c &\implies \text{all the clusters are finite almost surely,} \\ p > p_c &\implies \text{there exists an infinite cluster almost surely.} \end{aligned}$$

In a groundbreaking work, Kesten (1980) proved that $p_c = 1/2$ for Bernoulli percolation on the square lattice and obtained a precise description of the subcritical phase ($p < p_c$) and the supercritical phase ($p > p_c$). The behaviour at $p = p_c = 1/2$ is still the object of famous conjectures in the field, and the present article reviews some recent progress in the study of this critical regime.

We refer to the manuscripts of Grimmett (1999), Bollobás and Riordan (2006) and Werner (2009) for general background on percolation theory.

Organization of this article. — In Section 2, we state the new rotation invariance result of Duminil-Copin, Kozłowski, Krachun, Manolescu, and Oulamara (2020), and explain its relation to conformal invariance and universality of planar percolation in Section 3. The proof of rotation invariance relies on a discrete tool, the star-triangle transformation. In Section 4, we introduce this transformation, and in Section 5 we explain how it can be used to study the symmetries of certain percolation quantities. In Section 6, we discuss the role of the embedding of the graph and explain how the proof reduces to a key stability lemma.

2. CROSSING PROBABILITIES AND ROTATION INVARIANCE

In this section, we consider critical Bernoulli percolation at $p = p_c = 1/2$ and we discuss the rotation invariance result of Duminil-Copin, Kozłowski, Krachun, Manolescu, and Oulamara (2020). To keep this presentation light, we state a weaker version of the result: first we restrict to Bernoulli percolation, while the original result applies to more general models (FK percolation). Second, we state it in terms of rectangle crossings: the original result states that the whole collection of clusters is rotationally invariant, after a suitable truncation. Stating this strong result would require more background, in particular a careful definition of the state space for the collection of clusters.

For every a, b such that $0 \leq a \leq b$, we define the rectangle

$$R_{a,b} = [-a, a] \times [-b, b].$$

Through this article we identify \mathbb{R}^2 with the complex plane \mathbb{C} . In particular, we see $R_{a,b}$ as a subset of \mathbb{C} . Let ω be a critical Bernoulli percolation of the plane, seen as a random closed subset of \mathbb{C} . We say that $R_{a,b}$ is crossed in ω if there exists an open path in $R_{a,b} \cap \omega$ from the left side $\{-a\} \times [-b, b]$ to the right side $\{a\} \times [-b, b]$. We write $R_{a,b}^\theta$ for the rotation of $R_{a,b}$ with angle θ around 0, and say that $R_{a,b}^\theta$ is crossed in ω if there exists an open path in $R_{a,b}^\theta \cap \omega$ connecting the images (under the θ -rotation) of the left and right sides of $R_{a,b}$. See Figure 1 for an illustration of this event. We emphasize

that the connection probabilities are defined in terms of continuous subsets of the plane, hence the crossing events are well defined for arbitrary real numbers a, b, θ .

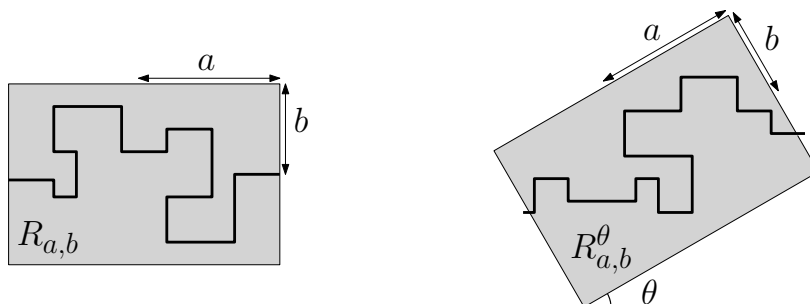

FIGURE 1. Diagrammatic representations of the events that $R_{a,b} = R_{a,b}^0$ is crossed (left) and $R_{a,b}^{\theta}$ is crossed with an arbitrary angle θ (right). In both cases, the solid path represents an open path connecting the left side to the right side of the rectangle.

Russo (1978), Seymour and Welsh (1978) proved that crossing probabilities with a fixed aspect ratio are non degenerated: For every fixed λ, θ , there exists $c > 0$ such that

$$\forall n \geq 1 \quad c \leq \mathbb{P}[R_{\lambda n, n}^{\theta} \text{ is crossed in } \omega] \leq 1 - c.$$

The asymptotic behaviour of the critical crossing probabilities is not yet rigorously understood, and is the object of a major open problem (see e.g. Langlands, Pichet, Pouliot, and Saint-Aubin, 1992), that we can state as follows.

CONJECTURE 2.1. — *Consider a Bernoulli percolation ω on the square lattice with parameter $p = p_c = 1/2$.*

- (i) *For every $\lambda \geq 1$, $\theta \in [0, \pi/2]$, the sequence $(\mathbb{P}[R_{\lambda n, n}^{\theta} \text{ is crossed in } \omega])_{n \geq 1}$ converges as n tends to infinity.*
- (ii) *For every $\theta \in [0, \pi/2]$,*

$$\lim_{n \rightarrow \infty} P[R_{\lambda n, n}^{\theta} \text{ is crossed in } \omega] = \lim_{n \rightarrow \infty} P[R_{\lambda n, n} \text{ is crossed in } \omega].$$

The first part of the conjecture can be interpreted as a “dilatation invariance” of the model: the rectangle $R_{\lambda n, n}^{\theta}$ is a dilatation of the rectangle $R_{\lambda, 1}^{\theta}$ by a factor n , and the crossing probabilities for large rectangles do not depend on the dilatation parameter n . The second part corresponds to a rotation invariance: the crossing probabilities for large rectangles do not depend on the angle θ of the rectangle.

Three years ago, Duminil-Copin, Kozłowski, Krachun, Manolescu, and Oulamara (2020) proved that crossing probabilities are invariant under rotation (which corresponds to the second item of the conjecture above). More precisely they establish the following theorem.

THEOREM 2.2 (Duminil-Copin, Kozłowski, Krachun, Manolescu, and Oulamara, 2020)

Consider a Bernoulli percolation ω on the square lattice with parameter $p = p_c = 1/2$. For every $\lambda \geq 1$ and every rotation angle $\theta \in [0, \pi/2]$, we have

$$\mathbb{P}[R_{\lambda n, n}^\theta \text{ is crossed in } \omega] = \mathbb{P}[R_{\lambda n, n} \text{ is crossed in } \omega](1 + o(1))$$

as n tends to infinity.

Remarks:

- The case $\theta = \frac{\pi}{2}$ is easy because the lattice is already invariant under $\pi/2$ -rotation. In contrast, the invariance for $\theta \in (0, \pi/2)$ is nontrivial and can not be deduced from the symmetries of the lattice.
- A self duality argument (see e.g. Grimmett, 1999) implies that the rectangles of the form $[0, n + 1] \times [0, n]$ are crossed with probability $1/2$. Therefore, a direct corollary of Theorem 2.2 is that for every $\theta \in [0, \pi/2]$,

$$\lim_{n \rightarrow \infty} \mathbb{P}[R_{n, n}^\theta \text{ is crossed in } \omega] = \frac{1}{2}.$$

- The theorem does not state that the crossing probabilities converge and the first item in Conjecture 2.1 is still open.

3. CONFORMAL INVARIANCE AND UNIVERSALITY

A much stronger symmetry of the crossing probabilities is conjectured, namely they are expected to be conformally invariant (see Langlands, Pouliot, and Saint-Aubin, 1994 and references therein). To state the conjecture, we use the notion of conformal rectangles, that we now define. Let $\lambda \geq 1$. We call conformal rectangle of modulus λ a pair (Ω, ϕ) , where $\Omega \subset \mathbb{C}$ is a simply connected open set, and ϕ is a homeomorphism from the rectangle $R_{\lambda, 1}$ to $\overline{\Omega}$ such that its restriction $\phi|_{(0, \lambda) \times (0, 1)}$ is a conformal map from $(0, \lambda) \times (0, 1)$ to Ω .

For $n \geq 1$, notice that the blown up $(n \cdot \Omega, n \cdot \phi)$ is also a conformal rectangle of modulus λ , and in particular it has well-defined left and right sides. We say that $n \cdot \Omega$ is crossed if there exists an open path in $n \cdot \Omega$ from its left to its right side.

CONJECTURE 3.1 (Convergence to Cardy’s formula). — Consider a Bernoulli percolation ω on the square lattice with parameter $p = p_c = 1/2$. For every $\lambda \geq 1$, there exists $f(\lambda)$ such that for every conformal rectangle (Ω, ϕ) of modulus λ ,

$$\mathbb{P}[n \cdot \Omega \text{ is crossed in } \omega] \text{ converges to } f(\lambda) \text{ as } n \text{ tends to infinity.}$$

Conjecture 3.1 directly implies Conjecture 2.1, since rotations are particular conformal maps. The explicit expression for $f(\lambda)$ was provided by Cardy (1992) in terms of hypergeometric functions. Later, Carleson noticed that Cardy’s formula takes a simple form if one considers crossings in an equilateral triangle rather than in a rectangle. See Smirnov (2001, Corollary 1) or Beffara (2007).

One of the most famous results in the field is the proof of the convergence to Cardy’s formula and conformal invariance for critical site percolation on the triangular lattice by Smirnov (2001). See also Khristoforov and Smirnov (2021) for a recent version of the proof. This percolation process is defined by first considering a regular tiling of the plane with hexagons, and then independently declaring each hexagon open or closed with probability $1/2$. Even though the model has a different local description, the asymptotic behaviour is expected to be the same as the one for Bernoulli bond percolation. This is related to the concept of universality, which we now discuss.

Universality. — For every infinite planar graph, one can define a critical parameter p_c for the existence of an infinite cluster in Bernoulli percolation (site or bond). The value of p_c and the percolation properties at $p \neq p_c$ generally depend on the underlying graph. In contrast, it is expected that the behaviour at p_c is universal for a large class of planar graphs (see Beffara, 2008 and references therein for a modern discussion). In particular the convergence to Cardy’s formula and the emergence of conformal invariance is also expected for critical Bernoulli percolation on \mathbb{Z}^2 . Even though this statement is strongly supported by non-rigorous renormalization group methods, we are still lacking a rigorous derivation. The “magical” proof of Smirnov for the triangular lattice involves discrete holomorphicity: in some sense, conformal invariance is already present in the discrete model. For more general graphs, we expect this symmetry to emerge only in the scaling limit, and Smirnov’s proof does not extend. A more robust approach (inspired by the original physics argument) would be to decompose the proof into two steps: first prove dilatation, translation and rotation invariance, and then extend it to conformal invariance using that a conformal map looks locally like a composition of a dilatation, a translation and a rotation. Some symmetries are already automatic for Bernoulli bond percolation on \mathbb{Z}^2 , for example translation and $\pi/2$ -rotation invariance are inherited from the symmetries of the underlying lattice. Dilatation invariance, which corresponds to the existence of the limit, is quite natural from the renormalization perspective, but today, there is no known rigorous argument. The result of Duminil-Copin, Kozłowski, Krachun, Manolescu, and Oulamara (2020) is particularly impressive because the rotation symmetry was a priori the most mysterious symmetry, and also the most delicate to study (since it is very sensitive to the choice of the embedding of the underlying graph). It is definitely a major step towards a proof of the conformal invariance of critical planar percolation.

4. STAR-TRIANGLE TRANSFORMATION

Let $p, q, r \in [0, 1]$. In this section, we consider inhomogeneous Bernoulli percolation on two simple weighted graphs, the triangle-graph $\Delta = (V, E)$ with weights (p, q, r) and the star-graph $Y = (W, F)$ with weights $(1 - p, 1 - q, 1 - r)$ as defined on Figure 2. Inhomogeneous means here that the probability to be open can be different for different

edges. If an edge has weight p_e , it is open with probability p_e , and closed with probability $1 - p_e$, independently of the other edges.



FIGURE 2. The triangle-graph Δ (left) and the star-graph Y (right).

We define the random partition ξ^Δ of $\{A, B, C\}$ associated to the Bernoulli percolation ω on the triangle graph Δ as follows: two vertices are in the same element of the partition if they are connected in ω . For example, if the edge AB is open and the two other edges are closed, we have $\xi^\Delta = \{AB, C\}$ (by abuse of notation, we write AB for $\{A, B\}$ and C for $\{C\}$). Similarly, we can define the random partition ξ^Y resulting from Bernoulli percolation on the star-graph. The star-triangle relation, stated below, asserts that these two partitions have the same distribution if the weights satisfy a certain relation. It was first discovered by Kennelly (1899) in the context of electrical networks. Also known as the Yang-Baxter equation in the physics literature, it was instrumental in work of Onsager (1944) who adapted it to the Ising model, and in the more general study of exact integrability (see e.g. Baxter, 1982). An important application for Bernoulli percolation was found by Sykes and Essam (1964), who used it to predict the critical values for bond percolation on triangular and hexagonal lattices.

PROPOSITION 4.1. — *If the edge weights satisfy*

$$(1) \quad p + q + r - pqr = 1,$$

then the two random partitions ξ^Δ and ξ^Y have the same distribution.

Proof. — We prove that for each of the five partitions P of $\{A, B, C\}$ we have

$$\mathbb{P}[\xi^\Delta = P] = \mathbb{P}[\xi^Y = P].$$

Since all the probabilities sum to 1 and the three partitions with two elements play symmetric roles, it suffices to check the identity above for $P = \{AB, C\}$ and $P = \{ABC\}$.

Let us first consider the partition $\{AB, C\}$, where A, B are connected together, and C is isolated. On the triangle graph, we obtain this partition if and only if AB is open, and the two other edges are closed. Therefore, we have

$$\mathbb{P}[\xi^\Delta = \{AB, C\}] = r(1-p)(1-q).$$

On the star-graph, this happens if and only if OC is closed and the two other edges are open. Therefore, we also have

$$P[\xi^Y = \{AB, C\}] = r(1-p)(1-q).$$

Consider the partition $\{ABC\}$ where all the vertices are connected together. On the triangle graph, this happens if and only if at least two edges are open. Hence

$$\begin{aligned} \mathbb{P}[\xi^\Delta = \{ABC\}] &= pq(1-r) + p(1-q)r + (1-p)qr + pqr \\ &= pq + pr + qr - 2pqr. \end{aligned}$$

On the star-graph, we obtain this partition if and only if the three edges are open. Therefore

$$\mathbb{P}[\xi^Y = \{ABC\}] = (1-p)(1-q)(1-r) = 1 - p - q - r + pq + pr + qr - pqr,$$

and the relation (1) yields $\mathbb{P}[\xi^\Delta = \{ABC\}] = \mathbb{P}[\xi^Y = \{ABC\}]$. \square

How star-triangle transformations can reveal hidden symmetries? On a graph without symmetry, it is hard to compare connection probabilities: for example, given three vertices O, A, B , can one compare the probability that O is connected to A with the probability that it is connected to B ? In the simple example below, we show how the star-triangle transformation can be used to reveal symmetries of the percolation probabilities.

Let $p \in (0, 1)$ be the unique solution of the cubic equation $3p - p^3 = 1$ in $(0, 1)$ and write $q = 1 - p$. Consider the weighted graph G represented on Figure 3, with vertices A, B, C, D, E . Consider a Bernoulli percolation ω , where the weight of an edge

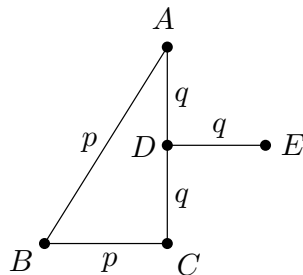

FIGURE 3. A graph with a hidden percolation symmetry

corresponds to the probability that the edge is open. We claim that for percolation on this graph, the probability of A being connected to B is equal to the probability of A being connected to E . To see this, consider the weighted graph G' with vertices A', B, C', E' drawn below.

This new graph can be obtained from G by applying a star-triangle transformation on the “star” in G bounded by ACE and replace it by a triangle $A'C'E'$ (the vertex D is simply deleted and the rest of the graph is left unchanged). By applying Proposition 4.1, we see that the connection probabilities between the vertices A, B, C, E are not affected

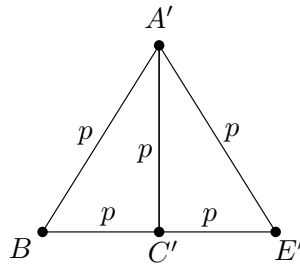

FIGURE 4. The symmetric graph G' obtained from G after a star-triangle transformation

by this transformation: If ω is a percolation on G and ω' a percolation on G' , then we have

$$\mathbb{P}[A \overset{\omega}{\leftrightarrow} B] = \mathbb{P}[A' \overset{\omega'}{\leftrightarrow} B] \quad \text{and} \quad \mathbb{P}[A \overset{\omega}{\leftrightarrow} E] = \mathbb{P}[A' \overset{\omega'}{\leftrightarrow} E'],$$

where $X \overset{\eta}{\leftrightarrow} Y$ means that X is connected to Y in η . Using the reflection symmetry of the new graph G' , we obtain the desired identity.

Of course, on this simple example, one could have checked this identity by simply computing the probabilities, but for large graphs, exact computations are impossible in practice. In contrast, the star-triangle transformation can be applied repeatedly to compare connection probabilities on large graphs (and even infinite graphs), as discussed in the next section.

5. A HIDDEN ROTATION SYMMETRY

In this section, we give another concrete example of a graph G with no clear symmetry, and we show that symmetries emerge when we look at percolation properties. The graph G plays an important role in the approach of Duminil-Copin, Kozłowski, Krachun, Manolescu, and Oulamara (2020) to prove that critical percolation on \mathbb{Z}^2 is rotation invariant.

Let $n \in \mathbb{N}$, and write $k = e^{i\pi/4}$. The complex number k can be understood as a parameter that governs the embedding of the considered graphs. In this section, the precise embedding is not important and our choice of $k = e^{i\pi/4}$ is arbitrary. In Sections 6 and 7, we will discuss percolation properties that are affected by embedding and we will choose more general parameters of the form $k = e^{i\theta}$, $\theta \in (0, \pi/2)$.

Consider the graph H with vertex set $F_f \cup F_u \cup F_r$, where

$$\begin{aligned} F_f &= \{x + iy : 0 \leq x, y \leq n\}, \\ F_u &= \{ni + x + ky : 0 \leq x, y \leq n\}, \\ F_r &= \{n + kx + iy : 0 \leq x, y \leq n\}. \end{aligned}$$

and edges between two vertices at Euclidean distance one of each other. As illustrated in Figure 5, the graph H can be seen as a planar representation of a three-dimensional

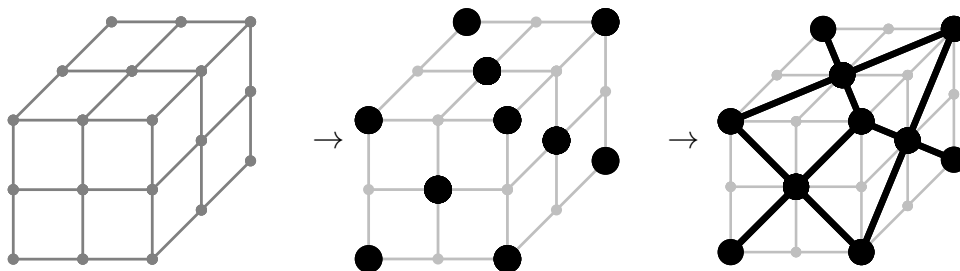

FIGURE 5. The left picture represents the graph H with $n = 2$. In the middle, the black dots represent the corresponding set V . On the right, the graph G is drawn in black.

$n \times n \times n$ “full” cube, filled with small cubes of size one. The vertices of F_f , F_u and F_r correspond to the front, upper, and right visual faces of the cube, respectively.

Notice that the graph H is planar and bipartite: its vertices can be partitioned into two sets V and V^c such that all the edges of H connect a vertex in V with a vertex in V^c . Fix V to be the unique such set which contains the origin 0 . Construct the graph $G = (V, E)$ with vertex set V and edge set E given by the pairs of vertices bounding the same face (a small square or rhombus) in H . See Figure 5 for an illustration of the construction of G in the case $n = 2$. We define the boundary ∂G as the set of all the vertices of G with degree 1 or 2.

We now associate some weights to the edges of G . Fix $p, q \in (0, 1)$ such that

$$2p + 2q - pq = 1.$$

For each edge $e = \{v, w\}$, write $\vec{e} = v - w$ with the convention that the x -coordinate of \vec{e} is positive, and define the weight (illustrated on Figure 6)

$$(2) \quad p_e = \begin{cases} 1/2 & \text{if } \vec{e} = 1 + i \text{ or } 1 - i, \\ p & \text{if } \vec{e} = 1 + k, \\ 1 - p & \text{if } \vec{e} = 1 - k, \\ q & \text{if } \vec{e} = k + i, \\ 1 - p & \text{if } \vec{e} = k - i. \end{cases}$$

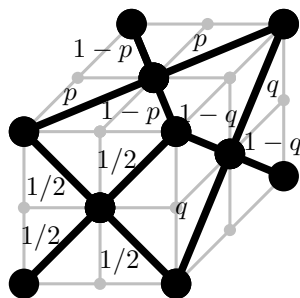

FIGURE 6. Representation of G and its associated weights for $n = 2$.

Notice that the edges between vertices of the front face F_f have the weight $1/2$, the edges on the upper face F_u receive the weights p or $1 - p$ and the edges on the right face F_r receive the weights q or $1 - q$.

Let r be the π -rotation of the plane with center $C = \frac{n}{2}(1 + i + k)$. If n is an even integer, then the boundary ∂G is invariant under the rotation r . Therefore, for every partition P of G , we can define a rotated partition $r \cdot P$, the elements of which are the images of the elements of P under the rotation r . An inhomogeneous Bernoulli percolation ω on the weighted graph G gives rise to a random partition ξ of ∂G : two vertices of ∂G are in the same element of the partition ξ if they are connected together in ω . We can rotate ξ , and consider another random partition $r \cdot \xi$ of ∂G . At first, the distributions of ξ and $r \cdot \xi$ seem to be different, since the underlying graph is not invariant under r . Despite this lack of symmetry of G , we will be able to use the star-triangle transformation to show that the random partition ξ is rotation invariant, as formally stated in the following proposition.

PROPOSITION 5.1. — *Let $n \geq 2$ even and consider the graph G as above. Let ξ be the partition of ∂G generated by Bernoulli percolation on the weighted graph (G, p) . For every partition P of ∂G , we have*

$$\mathbb{P}[\xi = P] = \mathbb{P}[r \cdot \xi = P].$$

Sketch of proof. — Let $G' = r \cdot G$ be the image of G under the π -rotation around C .

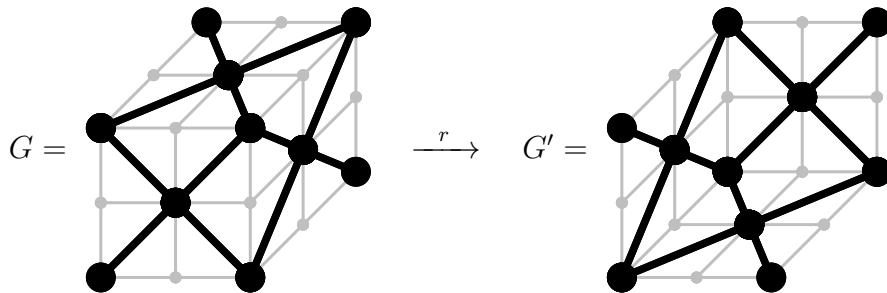

Since n is even, G and G' have the same boundary. It is immediate that the partition ξ' of $\partial G'$ generated by percolation on G' has the same distribution as $r \cdot \xi$, since a Bernoulli percolation on G' can be obtained by rotating a percolation on G . As a consequence, for every partition P of ∂G , we have

$$\mathbb{P}[\xi' = P] = \mathbb{P}[r \cdot \xi = P].$$

We now show that G' can be alternatively obtained from G by using successive star-triangle transformations, without rotation. This will imply that ξ' and ξ have the same distribution, and therefore conclude the proof.

We first start by constructing a sequence of graphs interpolating from H to H' , defined as the image of H under a π -rotation around C . As mentioned above, the graph H can be visualized as a three-dimensional $n \times n \times n$ cube, filled with n^3 small cubes of size one. Similarly, the graph H' can be seen as an emptied version of it. With this

interpretation, a natural way to go from H to H' is to “remove small cubes” one by one as illustrated on Fig. 5 for $n = 2$. This defines a sequence of graphs

$$H = H_0, H_1, \dots, H_{n^3-1}, H_{n^3} = H'.$$

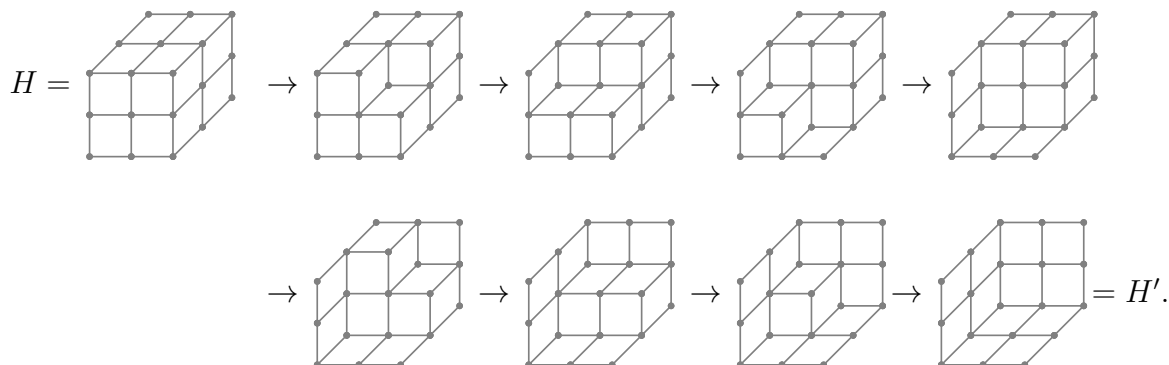

FIGURE 7. Transforming H to H' by “removing cubes” one by one

For every i , the graph H_i is bipartite and planar, and we can define a weighted graph G_i associated to H_i exactly as we defined G from H . In particular all the edges e of G_i are such that \vec{e} belongs to $\{1+i, 1-i, k+1, k-1, k+i, k-i\}$, and we can define the weights of the edges of G_i following Equation (2).

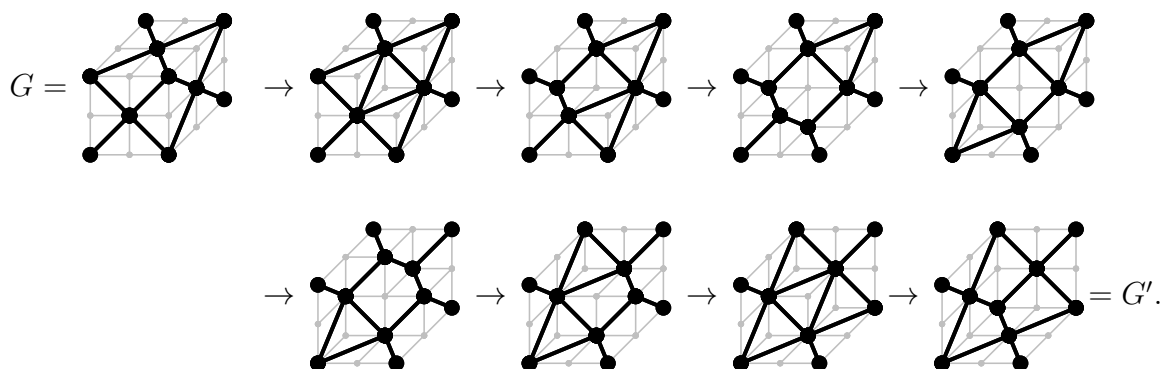

FIGURE 8. Local transformations from G to G'

The key observation is that G_{i+1} is obtained from G_i by applying one star-triangle transformation (at the place where the small cube is removed in H_i). If i is even, a star with weights $(1-p, 1-q, 1/2)$ is replaced by a triangle with weights $(p, q, 1/2)$ (as illustrated in Figure 9). Analogously, if i is odd, a triangle with weights $(p, q, 1/2)$ is replaced by a star with weights $(1-p, 1-q, 1/2)$.

In particular, the random partitions ξ_i and ξ_{i+1} of ∂G resulting from percolation on the weighted graphs G_i and G_{i+1} have the same distribution (since none of the vertices of ∂G is removed by the transformation). By induction, we deduce that $\xi = \xi_0$ and $\xi' = \xi_{n^3}$ have the same distribution: for every partition P of ∂G , we have

$$\mathbb{P}[\xi = P] = \mathbb{P}[\xi' = P].$$

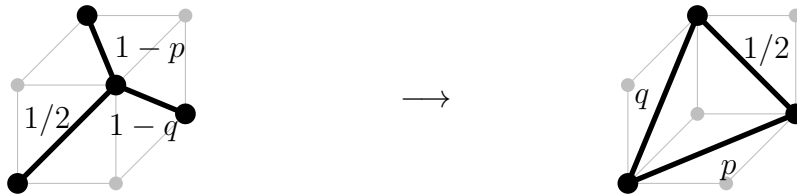

FIGURE 9. For i even, “removing one cube” corresponds to a star triangle transformation on G_i .

Since ξ' has the same distribution as $r \cdot \xi$, this concludes the proof. \square

6. ISORADIAL EMBEDDING OF THE CUBE GRAPH

In the previous sections, we saw that star-triangle transformations relate the percolation properties of two different graphs: the connection probabilities of the vertices left unchanged after several transformations are invariant. For example, when going from G to G' , none of the vertices of ∂G is affected by the local transformations, and their connection probabilities are therefore left unchanged. However, analyzing the percolation properties of the *bulk vertices* (i.e., the vertices of G' or G that are not at the boundary) is much more delicate. This complexity arises from the fact that when we go from G to G' , all the bulk vertices of G are deleted. At some point, each bulk vertex becomes the center of a star-graph, which is transformed into a triangle, and the connection probabilities to such vertex are “lost” in the process.

In all the star-triangle statements we have seen so far, the identities were graph properties, and they were insensitive to the precise way the graphs were embedded in the plane. In Section 5, we chose the same embedding for all the graphs G , regardless of the values of p and q . However, in the study of bulk vertices, it becomes crucial to choose a suitable embedding for the graph G , which depends on the values of the weights p and q . We will now describe the isoradial embedding of the graph G , which represents the “correct” way to embed it in order to preserve both boundary and bulk connectivity properties.

Let $\theta \in [0, \pi/2]$. We consider the plane graph $G = G_n(k, p, q)$ to be exactly the same graph as in Section 5, with the following choice of parameters:

$$(3) \quad k = e^{i\theta}, \quad \frac{p}{1-p} = \frac{\sin(\frac{\theta}{3})}{\sin(\frac{\pi-\theta}{3})}, \quad \frac{q}{1-q} = \frac{\sin(\frac{\pi+2\theta}{6})}{\sin(\frac{\pi-2\theta}{6})}.$$

These weights originate from the interpretation of G as an isoradial graph. They were first introduced in the work of Kenyon (2004), and their significance was further emphasized in the work by Grimmett and Manolescu (2014, 2013a,b). For a precise definition of isoradial graphs and more details about these weights, we direct the interested reader to these references. An important feature of these weights is that they satisfy the star-triangle relation:

LEMMA 6.1. — For every $\theta \in (0, \pi/2)$, the weights defined above satisfy

$$2p + 2q - pq = 1.$$

Proof. — First notice that the equation is equivalent to

$$x + y + 2xy = 1,$$

where $x = \frac{p}{1-p}$ and $y = \frac{q}{1-q}$. Using the explicit formula (3), this is again equivalent to

$$s_\theta s_{\pi/2-\theta} + s_{\pi-\theta} s_{\pi/2+\theta} + 2s_\theta s_{\pi/2+\theta} = s_{\pi-\theta} s_{\pi/2-\theta},$$

where $s_\phi = \sin(\phi/3)$. Finally, this last equation can be deduced by elementary trigonometric computations. For example, one can replace each term using that for every a, b, c ,

$$s_a s_b = \cos\left(\frac{a-b}{3}\right) - \cos\left(\frac{a+b}{3}\right).$$

□

We consider the following two regions in the plane

$$F = [0, n] + i \cdot [0, n], \quad \text{and} \quad U = in + [0, n] + k \cdot [0, n],$$

corresponding to the front and upper faces of G , respectively.

The part of G in the upper face U is invariant under the reflection with axis $in + \mathbb{R}e^{i\theta/2}$ (thick line in Figure 10), which implies the following θ -rotation invariance property for rectangle crossings. Let $R = [a, b] \times [c, d] \subset U$ be a rectangle centered at $z = in + \frac{n}{2} + \frac{n}{2}e^{i\theta}$ and R' be the image of R under the θ -rotation around z . Alternatively, the rectangle R' can also be seen as a reflected version of R through the axis $in + \mathbb{R}e^{i\theta/2}$. The reflection symmetry mentioned above implies that R and R' are crossed with the same probability, as illustrated in Figure 10.

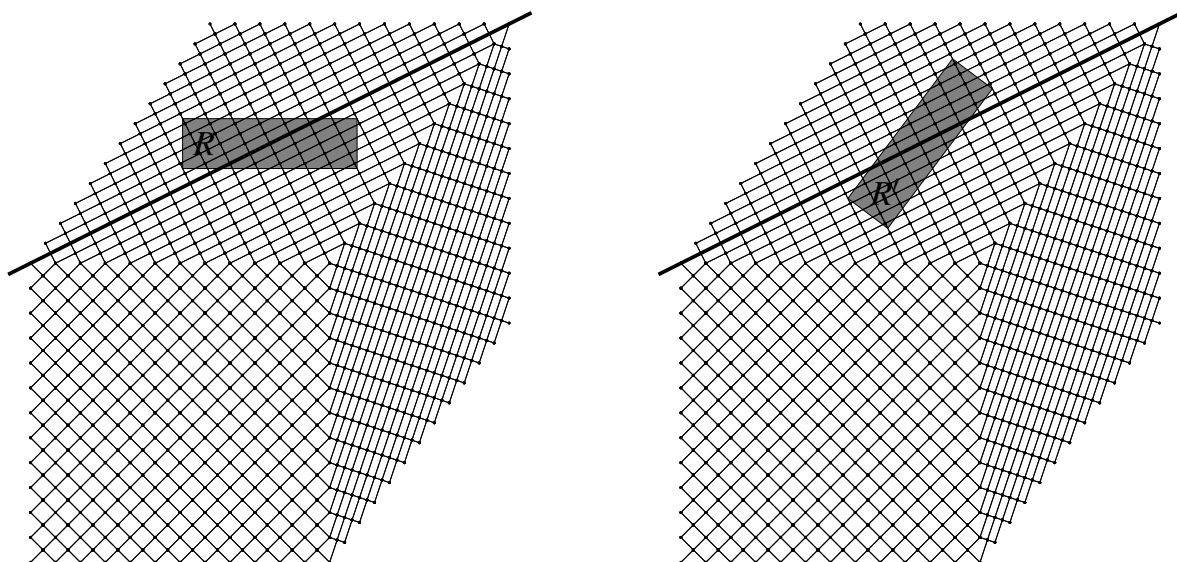

FIGURE 10. The rectangle R (filled in gray on the left) and its reflected version R' (right) have the same connection probabilities

Our aim is to “import” this symmetry from the upper face U to the front face F , in order to show that crossing probabilities in the front face F are also invariant under θ -rotation. To accomplish this, we rely on the star-triangle transformation to swap the two faces, together with a bulk stability result that ensures the preservation of percolation properties.

Let G' denote the π -rotated version of G , as discussed in Section 5. We define F' and U' as the images of F and U under the rotation that transforms G into G' .

Let $z' = \frac{n}{2} + \frac{n}{2}e^{i\theta}$ be the center of U' and consider the $\frac{n}{4} \times \frac{n}{8}$ rectangle centered at C' , defined by

$$R_n = z' + \left[-\frac{n}{8}, \frac{n}{8}\right] \times \left[-\frac{n}{16}, \frac{n}{16}\right].$$

Notice that this rectangle has aspect ratio $\lambda = 2$ and it is a translated version of the rectangle $R_{n/8, n/16}$ introduced in Section 2. For every $\phi \in [0, \pi/2]$, we define R_n^ϕ as the image of R_n after a ϕ -rotation around C' , the center of gravity of R_n . An important fact behind this choice is that all the rectangles R_n^ϕ belong to the F -face of G and the U' -face of G' if $\theta \in [\pi/4, \pi/2]$, as illustrated on Figure 11.

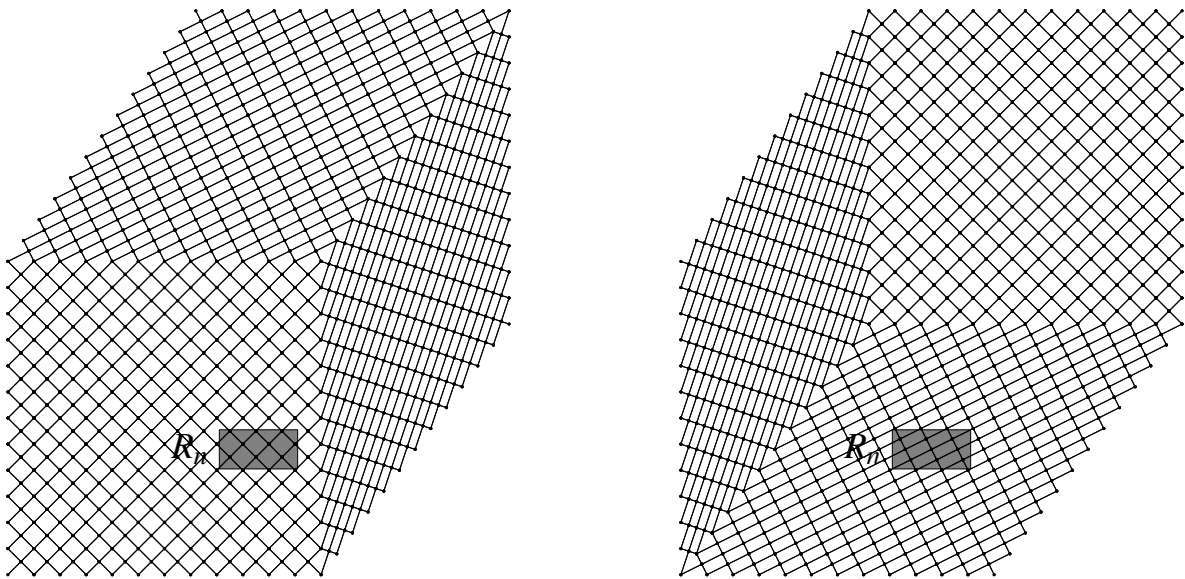

FIGURE 11. The rectangle R_n is a subset of the F -face of G (left) and is centered in the U' -face of G' (right).

The following statement constitutes the key lemma in the proof of Duminil-Copin, Kozłowski, Krachun, Manolescu, and Oulamara (2020):

LEMMA 6.2 (Bulk stability of crossings). — *Let $\theta \in [\frac{\pi}{4}, \frac{\pi}{2}]$. Let G be the weighted graph with parameters given by Equation (3), and G' its rotated version as above. Let ω and ω' be Bernoulli percolations on the weighted graphs G and G' respectively. For every $\phi \in [0, \frac{\pi}{2}]$, we have*

$$(4) \quad \mathbb{P}[R_n^\phi \text{ is crossed in } \omega] = \mathbb{P}[R_n^\phi \text{ is crossed in } \omega'](1 + o(1))$$

as n tends to infinity.

We now explain how to deduce the proof of the main result (Theorem 2.2) from this lemma. We restrict ourselves to rectangles with aspect ratio $\lambda = 2$ for simplicity, the proof trivially extends to general λ after minor adjustments. Let us fix $\theta \in [\pi/4, \pi/2]$. As mentioned at the beginning of the section, the upper face U has a $\theta/2$ -reflection symmetry. The U' -face of G' has the same property, which implies

$$(5) \quad \mathbb{P}[R_n \text{ is crossed in } \omega'] = \mathbb{P}[R_n^\theta \text{ is crossed in } \omega'].$$

We combine this observation with the stability result of Lemma 6.2. As n tends to infinity, we have

$$\begin{aligned} \mathbb{P}[R_n^\theta \text{ is crossed in } \omega] &= \mathbb{P}[R_n^\theta \text{ is crossed in } \omega'](1 + o(1)) && \text{by applying (4) to } \phi = \theta \\ &= \mathbb{P}[R_n \text{ is crossed in } \omega'](1 + o(1)) && \text{by (5)} \\ &= \mathbb{P}[R_n \text{ is crossed in } \omega](1 + o(1)) && \text{by applying (4) to } \phi = 0. \end{aligned}$$

This proves that R_n and R_n^θ are asymptotically crossed with the same probability for every fixed $\theta \in [\pi/4, \pi/2]$. We finally extend it to all angles θ by using reflection invariance of the homogeneous square lattice.

7. A RANDOM WALK ARGUMENT

In this section, we present the strategy used by Duminil-Copin, Kozłowski, Krachun, Manolescu, and Oulamara (2020) to establish the bulk stability of crossing probabilities (key Lemma 6.2). The aim is to show that connection probabilities in ω (Bernoulli percolation on G) and ω' (Bernoulli percolation on G') are close to each other. To achieve this, we couple these two configurations, and construct a sequence of intermediate configurations $\omega = \omega_0, \omega_1, \dots, \omega_n = \omega'$ where ω_j is a Bernoulli percolation on G_{n^2j} (as in Section 5, G_i denotes the graph obtained from G after performing i successive star-triangle transformations, visually corresponding to removing i “small cubes” in the underlying graph H). In particular, the configuration ω_{j+1} is obtained from ω_j by performing $\simeq n^2$ star-triangle transformations.

In this coupling, we keep track of all the macroscopic clusters (say, the clusters of radius larger than $0.0001n$). Fix one such cluster C_0 in ω_0 and consider the sequence of corresponding clusters C_1, C_2, \dots, C_n in the configurations $\omega_1, \dots, \omega_n$. To each cluster C_j of this sequence, associate its top-most left-most point X_j . The way X_j is affected by the star-triangle transformations is very local, and the authors show that X_0, X_1, \dots, X_n behaves like an n -step random walk. Therefore, by the law of large numbers, there exists some $\delta \in \mathbb{C}$ such that almost surely, we have

$$X_n = \delta n + o(n)$$

as n tends to infinity. A key step is then to show that the drift δ of this random walk vanishes. In a first version of their paper, the authors managed to prove this fact using a mapping to the six-vertex model, and the Bethe Ansatz. Recently the authors noticed that $\delta = 0$ follows from a simpler algebraic argument involving the symmetry of \mathbb{Z}^2 . This argument will be presented in a forthcoming version of their paper. As a consequence, X_n is at distance $o(n)$ from X_0 . This random walk argument can be extended to other points in order to show that open paths are not too much affected by the star-triangle transformations. Fix $\varepsilon > 0$. With probability $1 - o(1)$, the following holds: For every macroscopic open path γ in ω , there exists another open path γ' such that the Hausdorff distance between them satisfies

$$d_{\text{Hausdorff}}(\gamma, \gamma') \leq \varepsilon n.$$

The statement above asserts that ω and ω' can be coupled in such a way that all the macroscopic paths in ω are within εn distance from the macroscopic paths in ω' . From there, the desired result on crossing probabilities follows from a classical continuity argument in percolation theory.

REFERENCES

- Rodney J. Baxter (1982). *Exactly solved models in statistical mechanics*. Academic Press, London.
- Vincent Beffara (2007). “Cardy’s formula on the triangular lattice, the easy way”, in: *Universality and renormalization*. Vol. 50. Fields Inst. Commun. Amer. Math. Soc., pp. 39–45.
- (2008). “Is critical 2D percolation universal?”, in: *In and out of equilibrium*. 2. Vol. 60. Progr. Probab. Birkhäuser, Basel, pp. 31–58.
- Béla Bollobás and Oliver Riordan (2006). *Percolation*. Cambridge University Press, New York.
- Simon R. Broadbent and John M. Hammersley (1957). “Percolation processes. I. Crystals and mazes”, *Proc. Cambridge Philos. Soc.* **53**, pp. 629–641.
- John L. Cardy (1992). “Critical percolation in finite geometries”, *J. Phys. A* **25** (4), pp. 201–206.
- Hugo Duminil-Copin, Karol Kajetan Kozłowski, Dmitry Krachun, Ioan Manolescu, and Mendes Oulamara (2020). “Rotational invariance in critical planar lattice models”, arXiv: [2012.11672](https://arxiv.org/abs/2012.11672).
- Geoffrey R. Grimmett (1999). *Percolation*. Second. Vol. 321. Grundlehren der mathematischen Wissenschaften. Springer-Verlag, Berlin.
- Geoffrey R. Grimmett and Ioan Manolescu (2013a). “Inhomogeneous bond percolation on square, triangular and hexagonal lattices”, *Ann. Probab.* **41** (4), pp. 2990–3025.
- (2013b). “Universality for bond percolation in two dimensions”, *Ann. Probab.* **41** (5), pp. 3261–3283.

- Geoffrey R. Grimmett and Ioan Manolescu (2014). “Bond percolation on isoradial graphs: criticality and universality”, *Probab. Theory Related Fields* **159** (1-2), pp. 273–327.
- Arthur Edwin Kennelly (1899). “The equivalence of triangles and three-pointed stars in conducting networks”, *Electrical world and engineer* **34** (12), pp. 413–414.
- Richard Kenyon (2004). “An introduction to the dimer model”, in: *School and Conference on Probability Theory*. ICTP Lect. Notes, XVII. Abdus Salam Int. Cent. Theoret. Phys., Trieste, pp. 267–304.
- Harry Kesten (1980). “The critical probability of bond percolation on the square lattice equals $\frac{1}{2}$ ”, *Comm. Math. Phys.* **74** (1), pp. 41–59.
- Mikhail Khristoforov and Stanislav Smirnov (2021). “Percolation and $O(1)$ loop model”, arXiv: [arXiv:2111.15612](https://arxiv.org/abs/2111.15612).
- Robert P. Langlands, C. Pichet, Philippe Pouliot, and Yvan Saint-Aubin (1992). “On the universality of crossing probabilities in two-dimensional percolation”, *J. Statist. Phys.* **67** (3-4), pp. 553–574.
- Robert P. Langlands, Philippe Pouliot, and Yvan Saint-Aubin (1994). “Conformal invariance in two-dimensional percolation”, *Bull. Amer. Math. Soc. (N.S.)* **30** (1), pp. 1–61.
- Lars Onsager (1944). “Crystal statistics. I. A two-dimensional model with an order-disorder transition”, *Phys. Rev. (2)* **65**, pp. 117–149.
- Lucio Russo (1978). “A note on percolation”, *Z. Wahrscheinlichkeitstheorie und Verw. Gebiete* **43** (1), pp. 39–48.
- Paul D. Seymour and Dominic J. A. Welsh (1978). “Percolation probabilities on the square lattice”, *Ann. Discrete Math.* **3**, pp. 227–245.
- Stanislav Smirnov (2001). “Critical percolation in the plane: conformal invariance, Cardy’s formula, scaling limits”, *C. R. Acad. Sci. Paris Sér. I Math.* **333** (3), pp. 239–244.
- M. F. Sykes and John W. Essam (1964). “Exact critical percolation probabilities for site and bond problems in two dimensions”, *J. Mathematical Phys.* **5**, pp. 1117–1127.
- Wendelin Werner (2009). *Percolation et modèle d’Ising*. Vol. 16. Cours Spécialisés. Société Mathématique de France, Paris.

Vincent Tassion

ETH Zürich,
Rämistrasse 101,
8092 Zurich, Switzerland

E-mail : vincent.tassion@math.ethz.ch